

Installation and Operation Manual

Air Source Heat Pump Water Heater

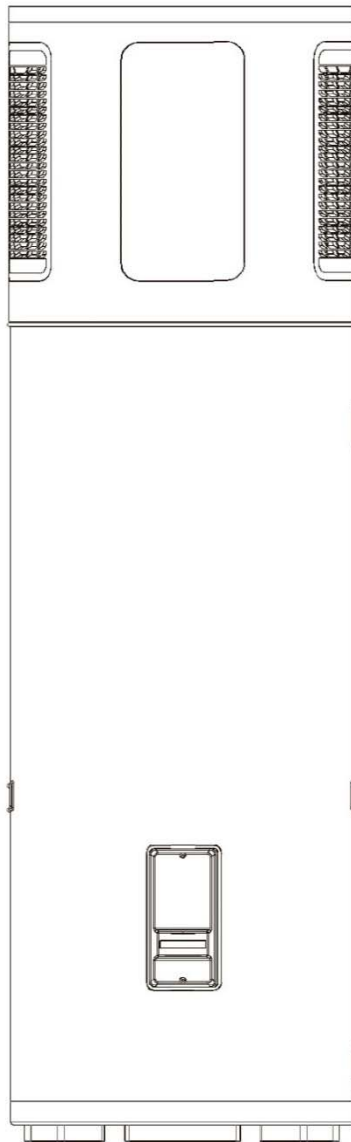

This water heater is only suitable for indoor environments and cannot be used in outdoor environments.

If the power cord is damaged, it must be replaced by a qualified person in order to avoid danger.

Table of Contents

1. Safety instructions

2. Product description

2.1 Product features

2.2 Working mode

2.3 Product appearance

3. Storage, handling, transportation and installation

3.1 Storage and transportation

3.2 Handling

4. Installation

4.1 Placement space requirements

4.1.1 Installation location and space requirements

4.1.2 Electrical requirements

4.2 Installation method

4.2.1 Equipment fixation

4.2.2 Water pipe connection

4.2.3 Condensate drain pipe

4.2.4 P/T valve installation

4.2.5 Thermal expansion tank (not provided)

4.2.6 Temperature limiting device (not provided)

4.2.7 Pressure limiting valve (not provided)

4.3 Installation check points

4.3.1 Water tank position

4.3.2 Pipeline connection

4.3.3 Condensate drain hose

4.3.4 P/T valve and drain line must comply with local regulations

4.3.5 Electrical connection

4.3.6 Check the control panel

4.3.7 Confirm whether there is a problem with the machine settings

4.4 Heat pump start-up

5. Operating instructions

5.1 Precautions for use

5.2 Safety warning

5.3 Operating instructions

5.3.1 Start-up & Shutdown operation

5.3.2 Temperature setting

5.3.3 Working mode setting

5.3.4 Time setting

5.3.5 Timing setting

5.3.6 Manual forced defrosting

5.3.7 Manual start of auxiliary electric heater

5.3.8 Child lock function

5.3.9 Screen protection function

6. Inspection and maintenance

6.1 Inspection and maintenance precautions

6.2 Inspection items

6.2.1 P/T valve

6.2.2 Water tank flushing

6.2.3 Water tank emptying

6.3 Holiday and long-time shutdown

6.4 Cleaning of condensate drain pipe

6.5 Refrigerating circuit

6.6 Magnesium anode rod maintenance

6.7 Check/Replacement of magnesium anode rod

7. Fault code display

8. Environmental protection

1. Safety instructions

The warnings in the manual are marked with a triangular warning sign.

Failure to comply with these warnings may result in serious consequences or even death.



Warnings

This water heater is not suitable for water heating in swimming pools.

The equipment should be placed where it won't damage the adjacent area or underlying structure of the heat pump water heater even if there is leak at the water heater or the joint. When these installation locations cannot be avoided, it is recommended to install a suitable water drain pan in the lower part of the water heater for adequate drainage of water.

If the water heater is installed in a closed water supply system, measures should be taken to prevent hot water from flowing back; for example, a check valve is installed on the cold water supply pipeline to prevent hot water from flowing back due to thermal expansion.

Before manually operating the temperature and pressure safety valve (hereinafter referred to as P/T valve), preventive measures must be taken to avoid the risk of scalds by the hot water flowing out from the P/T valve.

The thermal expansion of the closed water supply system may cause the P/T valve to periodically relieve pressure. Contact the water heater supplier for how to correct this situation. **DO NOT BLOCK THE P/T VALVE.**

The P/T valve should be inspected every 6 months for its performance or replaced at an interval of not more than 2 years. The P/T valve should be replaced more frequently in the high-occurrence areas of water subsidence.

When using and reusing the refrigerant, please comply with relevant environmental regulations. The refrigerant is not allowed to be discharged into the environment. R134a refrigerant is used for this equipment, which is non-flammable and does not have a devastating effect on the ozone layer.

When processing or operating components related to the refrigerant circuit, the refrigerant should be discharged to ensure safe operation.

The high pressure insulation test of the equipment can only be carried out between the live wire and the ground wire as well as the null line and the ground wire. The test between the live wire and the null line will damage the electronic equipment.

All electrical installation and wiring must be performed by qualified professionals and subject to wiring rules and the requirements of the local authority.

Risk of electric shock: Please turn off the power before performing equipment repairs. Failure to do so may result in serious personal injury or death.

When the circuit board, controller or display is repaired, all wires shall be first labeled and then disconnected. Wiring errors can result in incorrect and dangerous operation. The wiring must be reconfirmed after repair.

The water tank may be frost-cracked due to low temperatures. Do not turn off the power to the equipment. If it needs to turn off the power or there is a power outage, and there may be frost-crack because of low temperatures, the water should be discharged from the water tank.

Do not store or use gasoline or other flammable, explosive or corrosive gases and liquids near this equipment.

The water heaters must be installed, commissioned and repaired by authorized personnel in accordance with local laws and regulations.

It should ensure that the surrounding area of installed equipment is clean and free of flammable and corrosive materials such as gasoline and other flammable, explosive and corrosive gases and liquids, etc.

The power supply of the water heater can only be turned on after the water tank has been filled with water.

Water temperatures above 50 °C can immediately lead to severe burn or scald and death. Please feel the water temperature before bathing or showering.

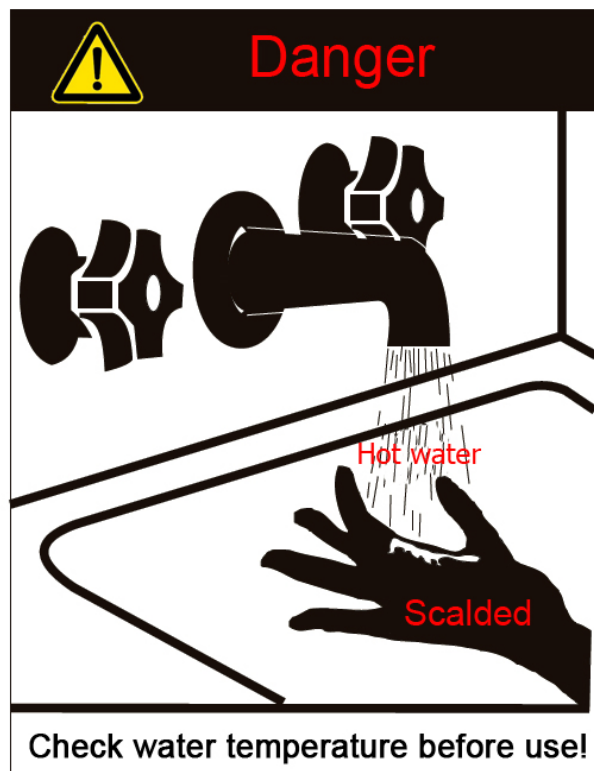

Prevent the risk of scald by high-temperature water:

In order to prevent scalds caused by excessively high water temperature, we recommend installing a temperature limiter at the junction of the hot water pipe and the sanitary water outlet (i.e the toilet and bathroom). This will keep the water temperature at the outlet below 50 °C, which can reduce the risk of scalds.

Water temperatures above 50 °C can cause severe scalds, and the local regulations and requirements regarding temperature limits primarily for personal sanitary hot water must be considered.

The water heaters must be installed by authorized personnel and the installation must comply with the local laws and regulations and the requirements of the supervision organization.

Faulty operation can result in death or serious injury.

This manual has clearly stated the possible risks. We will not be liable for any consequences resulting from failure to apply the equipment in accordance with the requirements of this manual.

2. Product description

2.1 Product features

Easy to operate

The equipment adopts the user-friendly control panel, which is easy for users to operate.

Energy saving and environmental protection

The equipment heats water by absorbing energy from the surrounding air and releasing it into the water stored in the tank, so it is very energy efficient. If the ambient temperature is low, the heating capacity of the heat pump will decrease, and then the auxiliary electric heater can be used as a backup.

Overheating protection

The water tank is equipped with a thermostat protection device located above the electric heater and it is in contact with the inner tank surface. If the water temperature reaches preset temperature or there is no water in the tank due to any cause, the thermostat will automatically cut off the power circuit of the electric heater.

When the water temperature is higher than 95 °C, the manual protection device of thermostat will cut off the power supply. If the temperature returns to the normal level later, the thermostat needs to be turned on by manual reset.

Manual reset of the thermostat should be performed by a qualified service personnel.



Warnings

The cause of abnormal high water temperature must be investigated by a qualified service technician and corrective measures must be taken before the water heater is restarted.

Automatic defrosting

In the operating state of heat pump, the equipment will automatically defrost to ensure thermal efficiency.

Water temperature or pressure protection

For your safety, the equipment is equipped with a P/T valve. If the tank pressure reaches 800 kPa or the temperature reaches 90°C, the valve will automatically open to allow the pressure or temperature to drop to a safe value.

Water supply pressure

The water heater is designed to be directly connected to the water system. When the water supply pressure exceeds 800 kPa, a pressure limiting valve must be installed. The minimum water supply pressure of 200 kPa is required to ensure the normal water supply of the water heater.

If the P/T valve or other safety devices has been tampered or not been installed in accordance with the instructions in this manual, the company will not be responsible for the consequences.

2.2 Working mode

• AUTO mode:

Water temperature setting: 35~75°C;

The heat pump can be heated up to 65°C at maximum, and it will shut down when the water temperature is heated to 65°C.

• Eco mode (Energy saving mode)

It is a timing mode.

The heat pump will automatically start and shut down when the startup & shutdown time is pre-set. It can be heated up to 65°C at maximum, and it will shut down when the water temperature is heated to 65°C.

Note: The default hot water outlet temperature is 55°C.

2.3 Product appearance

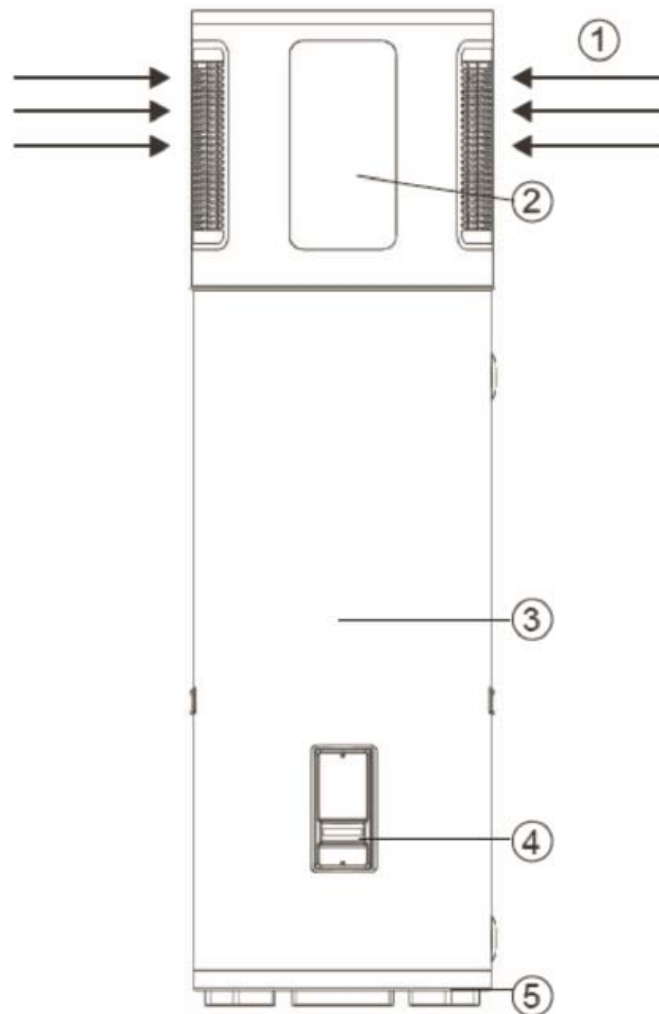

[1] Air inlet

[2] Control panel

[3] Water tank

[4] Electric heater & Thermostat

[5] Foot

3. Storage, handling, transportation and installation

3.1 Storage and transportation

As a rule, the equipment should be packed erectly and the water tank be stored or transported as an empty water tank. For short-distance transport, care should be taken to allow a tilt angle of 30° at maximum. Whether transported or stored, the ambient temperature should be in the range of -20 °C~+60°C.

3.2 Handling

When handled and transported by a forklift, the equipment must be fixed to the pallet at all times. The

lifting rate should be kept at the lowest limit. Due to the top-heavy weight, anti-overturn measures must be taken. To prevent any damage, the equipment must be placed on a level surface!

For manual handling, it is necessary to ensure that the lifting belt and pallet are used for the bottom. It must be noted that the maximum allowable tilt angle cannot exceed 30°. If tilting cannot be avoided during handling and transportation, the equipment can only be operated one hour after being moved to the final vertical position.

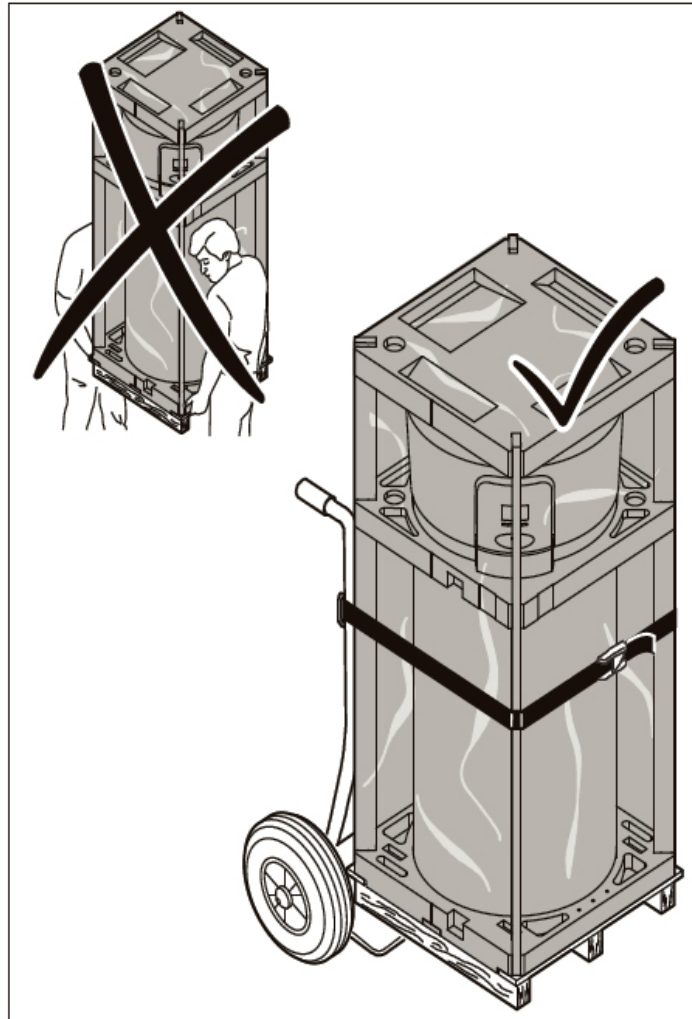

Warnings

Damage during transportation!

- ✧ **Avoid tilting the device over 30°.**
- ✧ **Be careful when handling equipment.**
- ✧ **To avoid dropping the equipment and damaging internal components, do not turn the equipment.**
- ✧ **To avoid equipment damage, the protective packaging shall be removed after the equipment has been transported to the installation site.**
- ✧ **Use straps to prevent the equipment from being scratched.**
- ✧ **Use the appropriate means of transportation to transport the equipment to the installation site (special vehicle, pallet truck, etc.)**

4. Installation

The manufacturer's warranty does not cover any damage caused by improper installation, connection or use of any type of accessory (except as listed in this user manual) of this water heater.

The use of unauthorized devices may shorten the life of the water heater and may result in death and property damage. The manufacturer is not responsible for any loss or damage caused by the use of such unauthorized devices.

4.1 Placement space requirements

Installation space requirements: to avoid affecting airflow, please ensure the equipment space requirements as shown.

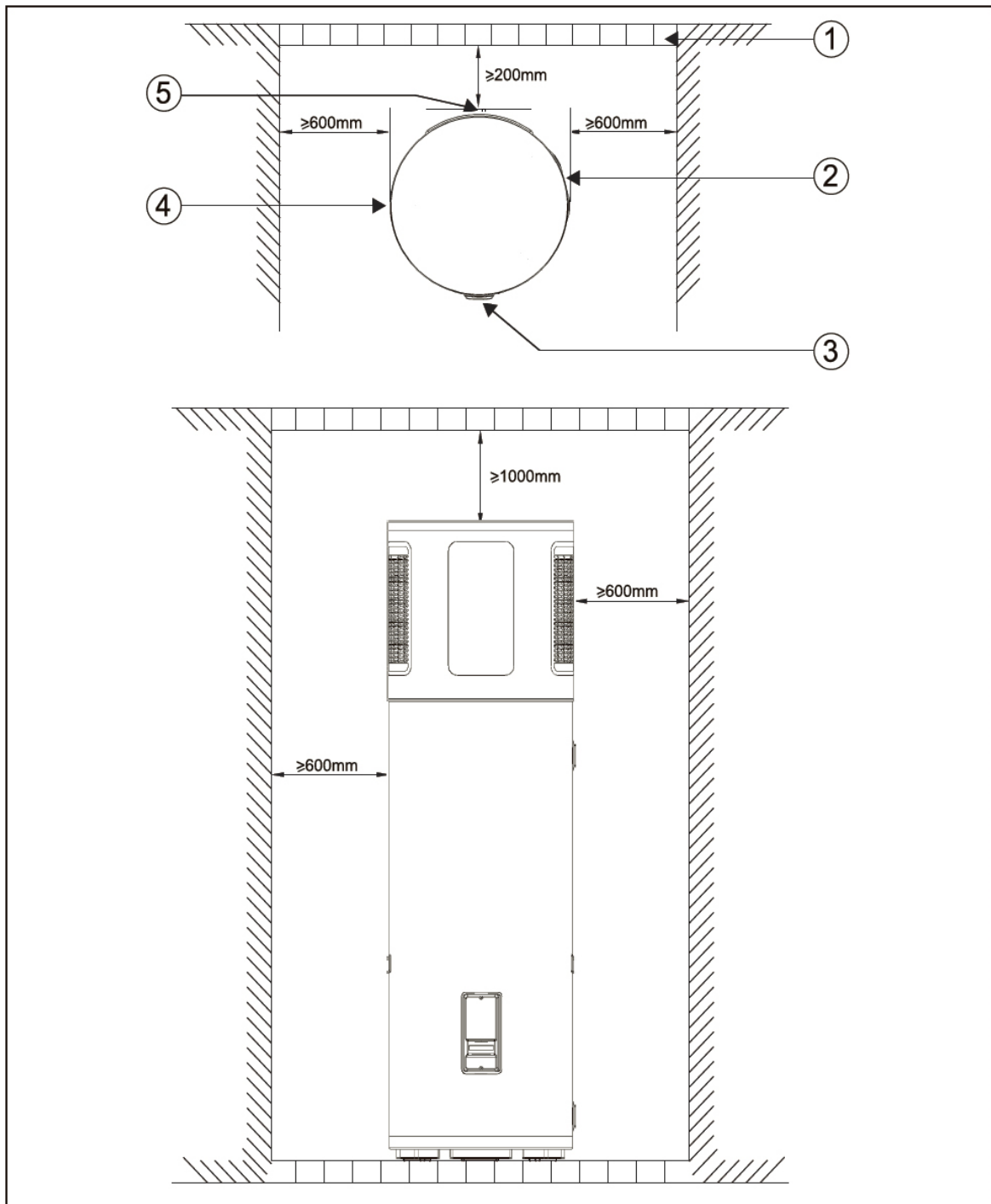

[1] Wall [2] Condensate drain outlet [3] Control panel [4] Air inlet [5] Air outlet



Warning

P/T valve coming with the equipment must be installed and the valve outlet must not be blocked, as this may be dangerous.

4.1.1 Installation location and space requirements

The water heater shall be installed in a clean place that is as close as possible to the area with the maximum hot water demand. The long non-insulated hot water pipes will waste energy and water.

Note: Because the equipment absorbs heat from the surrounding air to heat the water, when the equipment is used indoors, the space of the room must be at least 3mx3m x 2.5m (22.5m³) and it is better to be ventilated. If the room is smaller, there must be a louvered door or window with a ventilation area of at least 500mm².

When the water heater is placed, the space that is used for proper maintenance must be reserved, that is, the space required for removing the top cover, accessing to the P/T valve, and removing & installing the anode rod.

The entire equipment may be disassembled for future maintenance, so the water heater and water pipelines should be protected to prevent damage caused by severe cold and corrosive environments. In the place where the water heater is installed, there must be sufficient drainage facilities, such as floor drains, to drain the water in the tank when the tank is repaired or cleaned.



Warning

The water heater should not be installed in areas with corrosive atmospheres (such as the areas for storing chemicals and flammable liquids, or releasing aerosols). When using this equipment, these corrosive, flammable vapors may be brought out from the storage area due to convection of air in the room or other confined space. Any arc that may be generated at the electrically controlled live part of the water heater may ignite these vapors, thus causing an explosion or fire that could result in severe burns or even death and property damage.

Suggestions

Even if the equipment is running at a low level of noise, it is best to install it away from the bedroom or other resting place.

Condensate discharge

The condensate produced by the water heater needs to be discharged, so there must be a drainage device close to the equipment such as floor drain. The drainage device must be no more than 8cm above the ground.

If there is no drainage device, a drain pump with the volume not less than 4 liters/day must be purchased from a local supplier and then installed.

4.1.2 Electrical requirements

Power requirements

The power cord parameters are: 3 X 1.5mm² or above.

This water heater must be directly connected to the main power supply of 220V~50Hz.



Warning

All electrical installation and wiring must be performed by qualified personnel in accordance with the wiring rules required by local authorities.

The water heater needs to be connected to the user's power supply line through the earth leakage protective device. It must be noted that the user's power supply line must have a grounding wire.

The earth leakage protective device is not waterproof, and it should pay attention to preventing water flowing in when used.

Correct grounding connection is essential. The presence of water in pipes and water heater can not provide sufficient grounding conductivity. Non-metallic pipes, dielectrics, flexible connections, etc. may cause the water heater to be electrically isolated.

The electrical components and insulation tests in the water heater must be performed between the live wire and ground wire, as well as the null line and the ground wire. The test between the live wire and the null line will destroy the electronic components.

4.2 Installation method

4.2.1 Equipment fixation

- ◇ Remove the package and external protective packaging
- ◇ Pick up the equipment from the base
- ◇ Align the equipment with the mounting position correctly

Note: In order to ensure trouble-free operation, the equipment must be installed vertically and the installation tilt angle should not exceed 1°.

4.2.2 Water pipe connection



Warning

All piping work must be performed by qualified personnel in accordance with the requirements of local laws and regulations.

Care must be taken not to touch the pipelines as the temperature may be very high.
The supplied P/T valve must be installed, otherwise damage to the equipment or other property loss may be caused.

Installation of the inlet and outlet water pipelines: the inlet and outlet water threads are G3/4 (female thread). Pipelines must be high temperature-resistant, durable and weathering-resistant (outdoor installation).

Installation of P/T valve pipeline: The thread specification of the valve is G3/4 (male thread).
All pipelines should be insulated with suitable thermal insulation materials (if exposed, they must be weathering and UV-resistant) to optimize energy efficiency.

The typical installation drawing is as shown below.

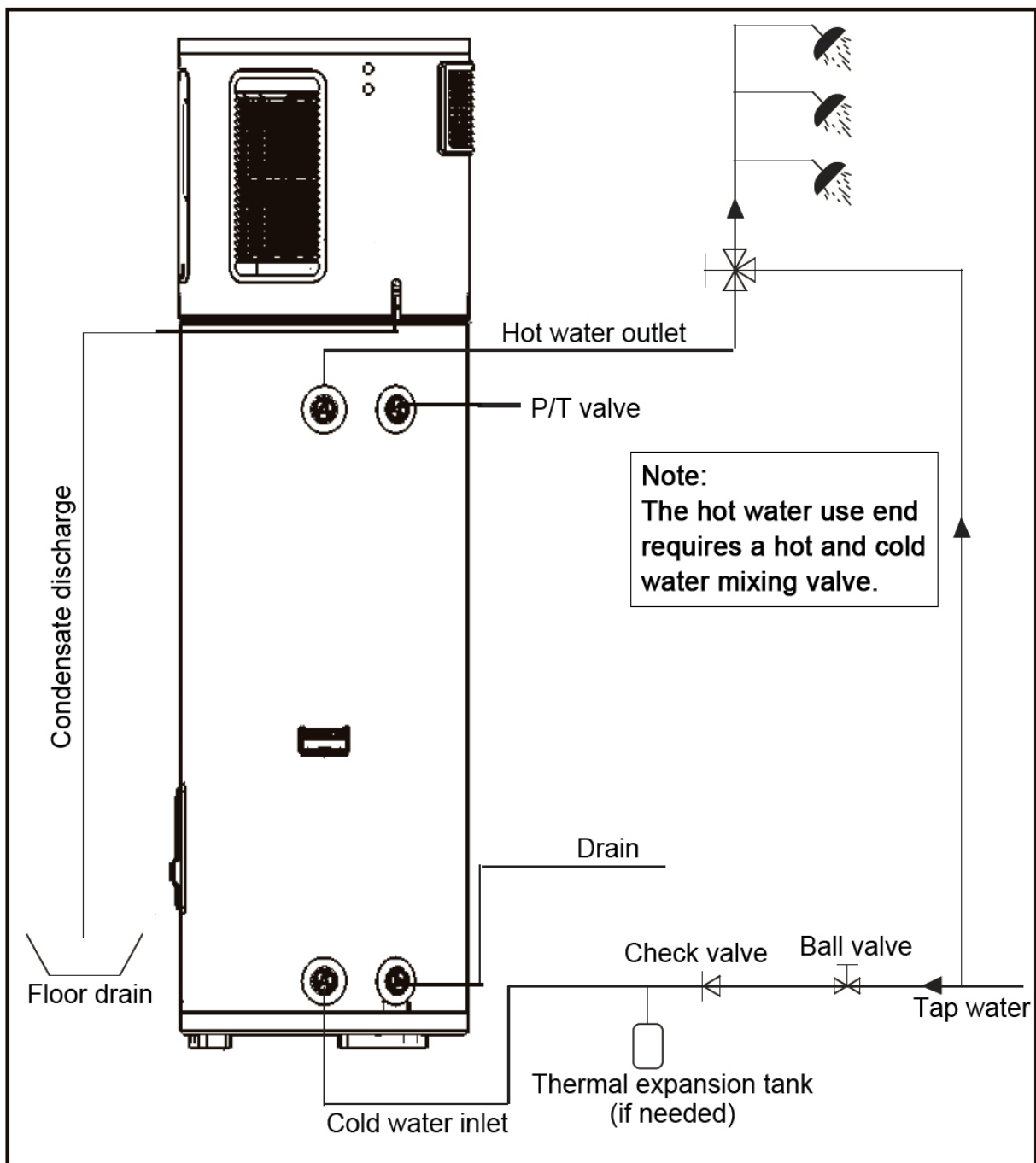

Water injection into water tank



Warning

Damage to the water heater

- ✧ First inject cold water into the tank before the commissioning of the equipment.
- ✧ Open the water outlet connection and one or more hot water taps.
- ✧ Open the cold water inlet of the storage tank, start injecting water into the water tank.
- ✧ Turn off the hot water tap when there are no air bubbles in the water stream.
- ✧ Connect the equipment to the power supply via the power cord.

Water quality requirements

Poor water quality will lead to a shortened product life. The magnesium rod shall be checked more frequently and replace it if necessary.

4.2.3 Condensate drain pipe

This water heater has an integrated condensate water pan. The water collected in the water pan is drained from the drain hole at the back of the water heater and its connected hose.

- ✧ Connect one end of the condensate drain pipe to the drain hole on the back of the water heater.
- ✧ The other end is directly connected to the floor drain or the outdoor ground that is not more than 8cm higher.

If this type of drain method is not possible, it is recommended to purchase and install a condensate drain pump (not supplied)

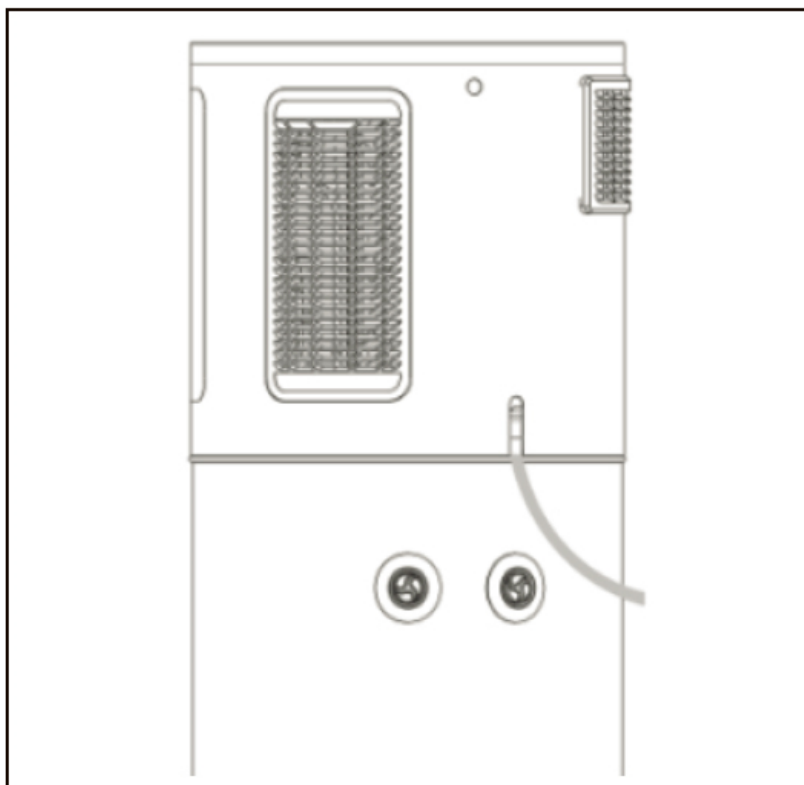

4.2.4 P/T valve installation

The P/T valve must be installed at the connection port marked “P/T valve” on the water heater. No other valve body or any other type of part should be installed between the P/T valve and the water tank. Please install the P/T valve correctly according to this valve's instruction manual.



Warning

The pressure rating of the P/T valve must not exceed 800 kPa.

The pressure relief device of the P/T valve shall be operated at least ONCE EVERY SIX MONTHS. When the operating lever is running, if the water cannot be discharged smoothly, the authorized relevant technician shall inspect the P/T valve or replace the P/T valve if necessary.

The P/T valve and its drain pipe must not be sealed or blocked. When heating the water, a small amount of water is allowed to leak from the P/T valve.

Once the P/T valve is installed on the water heater, its function is to discharge high temperature hot water under certain conditions. Therefore, it is highly recommended that the pipeline that connects the P/T valve can withstand temperatures higher than 99 °C. Failure to follow this advice can lead to dangerous situations.

Never block or seal the P/T valve or its drain outlet for any reason. If the P/T valve is changed arbitrarily or not installed in accordance with the instruction manual, the warranty will be invalid. It is recommended to connect a hose from the P/T valve outlet to the floor drain or a suitable drain device so that the drained water will not touch any electrical part, person or animal, thus eliminating any other possible risks.

In order to reduce the risk of excessive pressure or temperature in the water tank of the water heater, a P/T valve is required to be installed as the protection device as per the local laws and regulations.

4.2.5 Thermal expansion tank (not provided)

Thermal expansion is a natural process in which the volume of water is increased after it is heated. When the volume increase of the water stored in the water tank is limited, it will cause an increase in pressure. Increased pressure can lead to dangerous situations. If the safety settings on the P/T valve are already in place, the valve will act during the heating cycle. Generally, if the pressure in the tank reaches the nominal value of the valve, the excessive expansion may cause the valve to malfunction prematurely and accelerate the actuating force of the valve.

Therefore, it is recommended to install an expansion water tank to alleviate this kind of excessive pressure and avoid repetitive P/T valve action. For more information on this issue, please consult the relevant professional or water heater supplier.

4.2.6 Temperature limiting device (not provided)



Warning

The water heater can heat the water to a temperature that may lead to scalds.

It is recommended to install a temperature limiting device at the water heater and hot water outlet in the bathroom or similar location to reduce the risk of scalds.

4.2.7 Pressure limiting valve (not provided)

If the tap water supply pressure exceeds the product's pressure rating 800kPa, a pressure limiting valve is required to be installed at the water inlet pipeline.

If the tap water supply pressure is lower than the product's pressure rating 200kPa, a pressure increasing valve is required to be installed at the water inlet pipeline to provide the necessary pressure or reduce the generation of bubbles in the water system.

4.3 Installation check points

4.3.1 Water tank position

- ✧ The installation space must be at least 3m x 3m x 2.5m (22.5m³). If it can not be satisfied, window-blinds or similar ventilation devices are required.
- ✧ The back of the equipment shall be about 200mm away from the wall, and the left and right air inlets and outlets should be at least 600mm away from the wall.
- ✧ The front of the equipment should be unobstructed and clean.
- ✧ The top of the equipment must be at least 1000mm away from the ceiling.
- ✧ The bottom of the equipment must be flat, otherwise spacers need to be added.

4.3.2 Pipeline connection

Inject tap water into the water tank after the water pipes are connected and check if there is water leak at each joint.

4.3.3 Condensate drain hose

The condensate drain hose should be connected to the drain hole of the water pan and the floor drain, drain device or drain pump.

4.3.4 P/T valve and drain line must comply with local regulations

4.3.5 Electrical connection

- ✧ Electrical connections shall not obstruct the removal of the inlet and outlet air grids.
- ✧ All electrical connections require insulating treatment.

4.3.6 Check the control panel

- ✧ Verify whether each operation button on the control panel is flexible and displays normally
- ✧ Check whether the mode, temperature, time, and other function settings are correct. The default temperature is set to be 65 °C

4.3.7 Confirm whether there is a problem with the machine settings

Start up the water heater after confirming that there is no problem with the settings. Please pay attention to protecting the control panel.



Warning

The power supply cannot be activated before the water tank is filled with water.

4.4 Heat pump start-up

After the water heater is installed and all electrical and water connections are also determined and checked, it should be filled with water (the water tank is ensured to be filled with water by opening the hot water tap at somewhere in the home for drawing off water). Once the tank is filled with water and powered, the user must press the power button on the control panel to start the equipment. The startup process is as follows.

Time	Heat Pump	Notes
0---110 seconds	The equipment is with no action	Prevent compressor from damage.
110---170 seconds	Solenoid valve opens	
170---180 seconds	Fan starts	
180 seconds later	Compressor starts	High-efficient heat pump heating.

The ambient temperature range for heat pump operation is -5 °C ~ 43 °C. If the ambient temperature is outside this range, the heat pump will not operate and the auxiliary electric heater will start to heat the water instead of the heat pump. It will return to the heat pump mode when the ambient temperature restores to the operating temperature range -5 °C ~ 43 °C.

5. Operating instructions

5.1 Precautions for use

If any insulation material or covering is applied on the outside of the water heater, the following points need to be noted:

- ✧ Do not cover the P/T valve.
- ✧ Do not cover the lid of the auxiliary electric heater.
- ✧ Do not cover the operation, warnings and other marks on the water heater.
- ✧ Do not cover the air inlet and outlet.
- ✧ Do not cover the control unit of water heater.

5.2 Safety warning



Warning

Do not turn on the water heater if the cold water supply switch is off.

Turn off the power if the water heater is overheated or subject to fire, flood or other physical damage.





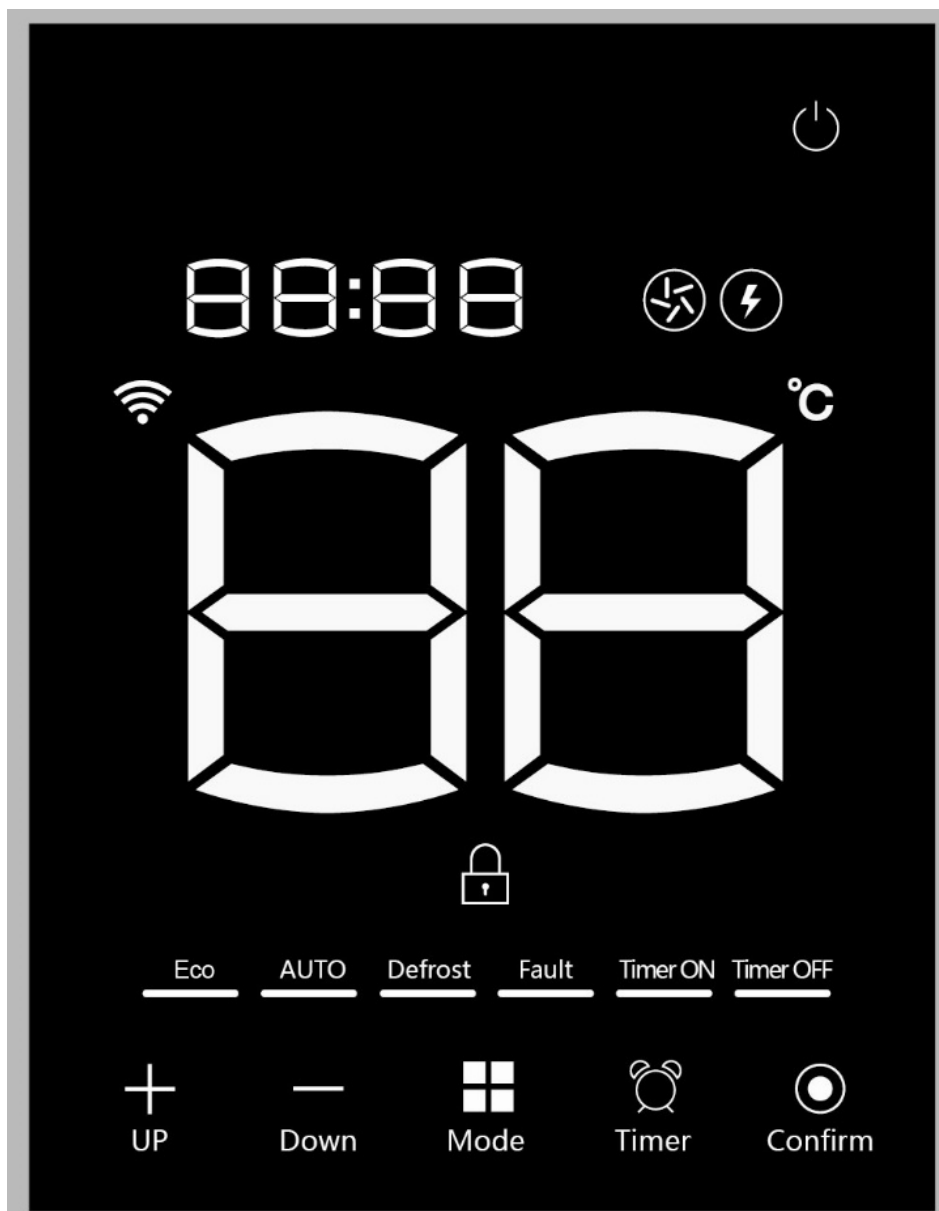

The installation, commissioning, maintenance and cleaning of the water heater must be completed by professional technicians or maintenance personnel.

5.3 Operating instructions

Operation interface



5.3.1 Start-up & Shutdown operation

- ✧ **Start-up:** Press the power button  to start it up when it is at the state of shutdown, and bright screen will be displayed from the center to the outside, accompanied by the rising tone of buzzer, then the temperature of the water tank will be displayed on  and the time displayed on .
- ✧ **Shutdown:** Press the power button  to shut it down when it is at the state of start-up, and dark screen will be displayed from the outside to the center, accompanied by the falling tone of buzzer. Then, the button  will be displayed with dark light.
- ✧ The power button  is always bright (except for the dark screen during 9: 00pm ~ morrow 6: 00am), which is displayed with dark light when the equipment is not turned on and during screen protection.

5.3.2 Temperature setting

- ✧ Press the “UP” or “Down” button to enter the temperature setting state,  flashes for temperature setting, press the “UP” or “Down” button to adjust the set temperature, and the temperature will be quickly adjusted when pressing and holding the “UP” or “Down” button. When the set temperature rises to the maximum or declines to the minimum value, a new counting cycle from the minimum or maximum will start.
- ✧ Press the “Confirm” button during the setting process, and the setting will take effect and exit.
- ✧ The setting will take effect and exit if it is not operated for 5s.
- ✧ Press the power button, and the setting will be invalid and exit.



5.3.3 Working mode setting

- ✧ Press the “Mode” button and release it to switch between “Eco” mode and “AUTO” mode. In the “Eco” mode, it will operate according to the preset working time period.
- ✧ “AUTO” mode: In this state of start-up, if the water tank temperature reaches the preset temperature, the system will stand by; if the water tank temperature is 6 °C lower than the preset water temperature, the system will start up.
- ✧ “Eco” mode: When it is in the timing period, operate according to the “AUTO” mode; when it is not in the timing period, the system stands by.

5.3.4 Time setting

- ✧ Press the “Timer” button to enter the time setting and the hour digit flashes.
- ✧ Continue to press the “Timer” button, and the time is adjusted as follows: hour → minute → exit.
- ✧ Press the “UP” and “Down” buttons to adjust the corresponding time value.
- ✧ The setting will automatically take effect and exit if the button is not pressed for 30s.
- ✧ Press the power button to be invalid and exit during the setting process.

5.3.5 Timing setting



- ✧ Press and hold the “**Timer**” button for 3s to enter the timing setting
- ✧ **Timing 1:** At this time, “**Timer ON**” is displayed, the digital “1” is displayed on , and the hour digital flashes. Press the “**UP**” and “**Down**” buttons to adjust the hour; after adjusting, press the “**Timer**” button again and “**Timer ON**” is displayed, the digital “1” is displayed on , and the minute digital flashes; press “**UP**” and “**Down**” buttons to adjust the minute; press “**Timer**” button again to enter the setting of “**Timer OFF**”, and the setting mode is the same as “**Timer ON**”.
- ✧ The setting will automatically take effect and exit if the button is not pressed for 30s.
- ✧ Press the “**ONI OFF**” button to be invalid and exit during the setting process.

Note: When the start time and end time of the timing period are set to be the same, it means that the timing period is invalid. If the end time of a certain time period is earlier than the start time, the end time is considered to be that on the next day. For example, if a time period is set to be "22:00~03:30", it is considered to be from 22:00 to 3:30am of the next day.

5.3.6 Manual forced defrosting

Press and hold the “**UP**” and “**Down**” buttons meanwhile for 5s, the forced defrosting will start. When the coil temperature is greater than the defrosting exit temperature, defrosting will not start.





5.3.7 Manual start of auxiliary electric heater

- ✧ Press and hold the “**Mode**” button for 3.5s to force the auxiliary electric heater to start.
- ✧ The  light flashes when auxiliary electric heater is started, and  is always on when it is successfully started.

5.3.8 Child lock function

Press and hold the power button for 3s to enter the lock state, and then press and hold the power button for 3s to release the lock.

5.3.9 Screen protection function

It will enter the screen protection state if it is not operated for 180 seconds, the  °C” displays the temperature of the water tank, the power button icon is illumed, and the brightness is reduced. During the period of 21:00 ~ tomorrow 6:00am, the lights , ,  and  shall be illumed according to the actual working conditions after it is not operated for 3 minutes by the user, and the rest are not displayed; when the button or relay action is detected in the screen protection state, the screen protection will exit, and if no operation is performed for 3 minutes after exiting the screen protection, it will enter the state of screen protection again.

6. Inspection and maintenance



Warning

The water heater should be repaired and maintained by professionals in accordance with local plumbing standards.

Before manually operating the P/T valve, make sure that no one will be exposed to danger because of contacting the hot water released by the valve. The water may not heat up to the level of scald, however it is still necessary to use a suitable drain pipe to release the water to avoid possible injury or property damage.

Periodic release of the P/T valve is part of normal operation. This is because there is thermal expansion in a closed water system that causes an increase in pressure. If such release becomes excessively frequent and continuous, please contact the after-sales service provider and don't block the outlet of the valve.

Note: Proper maintenance of the water heater will provide a longer, reliable, trouble-free and economical operating life.

It is recommended to establish a regular preventive maintenance program for the users to follow up.

6.1 Inspection and maintenance precautions

It is recommended that periodic inspections of the controller, heating elements, and wiring should be performed by qualified electrical service personnel.

It is recommended that the evaporator and refrigeration circuit be inspected and cleaned every 5 years for dust and residue. In dusty environments, they should be inspected and cleaned more frequently.

6.2 Inspection items

6.2.1 P/T valve

The lever handle of the valve should be lifted and released at least once every 6 months to ensure flexible operation of the valve.

A few liters of water shall be allowed to drain from the valve so as to flush the valve body, but the drained water should be connected to an external drain pipe to flow to the floor drain.

It is strictly forbidden to replace the existing P/T valve with a P/T valve that is higher than the pressure rating specified by the water heater.

If the valve body cannot drain water when the release lever is opened or it cannot be well sealed when the release lever is closed, it must be promptly replaced by a professional.

The P/T valve can not be repaired.



Warning

Before manually operating the P/T valve, make sure that no one is exposed to the hot water released by the valve body. The hot water discharged from the water tank may not be sufficient to cause scalds, but should be connected directly to an appropriate drain place to prevent injury or damage.

6.2.2 Water tank flushing

The suspended solids in water are easily deposited at the bottom of the tank. Therefore, it is normal to have hard water sediments at the bottom of the tank.

It is recommended to periodically drain the water and then inject water into the water tank to wash the sediments at the bottom of the tank.

6.2.3 Water tank emptying



Warning

Please turn off the power of the water heater before draining the water.

Risk of scalds!

Please check the hot water temperature of the water heater before opening the P/T valve. Until the water temperature drops to a level that is insufficient to cause scalds or other injuries.

Discharge water from the drain outlet, where a large amount of water will be drained. To ensure proper drainage, the following points need to be noted:

- ✧ Close all hot water taps.
- ✧ Isolate cold water supply.
- ✧ Remove the cold water inlet connection until the drain is stopped.
- ✧ Open a hot water tap.
- ✧ Wait until all the water is drained.

6.3 Holiday and long-time shutdown

If the water heater will be kept idle for a long period of time, in order to save energy, the power and water supply of the equipment should be turned off.

Although the water heater has an antifreeze function, if the water heater and pipeline may be subjected to freezing temperatures, both of them should be drained. After a long period of shutdown, the operation and control of the water heater should be checked by qualified maintenance personnel. Make sure the water heater is completely filled with water before running the water heater.

6.4 Cleaning of condensate drain pipe

The condensate drain outlet is located on the back of the water heater. If it is clogged, water will overflow from the outside of the water heater, so it is necessary to regularly clean and clear the condensate drain outlet.

- ✧ Remove the condensate drain pipe.
- ✧ Clear and unblock the debris and attachments from the drain outlet.
- ✧ Periodically inspect the drain pipe and remove any debris that may gather in the drain pipe.

6.5 Refrigerating circuit



Warning

Repairs to the refrigeration system circuits (e.g compressors, tank coils, evaporators, thermal expansion and solenoid valves, etc.) can only be carried out by authorized after-sales service providers.

6.6 Magnesium anode rod maintenance

The magnesium anode rod of water heater is the most important protective part against corrosion and premature failure for any water tank.

Therefore, it is very important to check the magnesium anode rod. It is generally recommended by the water heater industry to check the anode rod once a year.

Apartments that supply salty or softened water should consider being inspected more frequently. If there is any doubt, please consult your local plumbing expert.

If necessary, please contact an authorized person to inspect and replace the magnesium anode rod.

6.7 Check/Replacement of magnesium anode rod

The tank of the water heater shall be protected against corrosion by an internal magnesium anode rod.



Warning

Damage caused by the water heater operation without the protection of magnesium anode rod is not covered by our warranty.

It needs to check the magnesium anode rod every year and replace the magnesium anode rod if necessary.

The inner wall of the water storage tank is coated with an enamel coating, which is only used for the corrosion protection of normal water quality. When more corrosive water is used, the protection can only be effective if additional safety measure (anode rod) is taken and the magnesium rod is checked more frequently.

Check the protective magnesium anode rod:

- ✧ Disconnect the water heater from the power supply.
- ✧ Turn off the water supply.
- ✧ Remove the magnesium anode rod.
- ✧ Perform a visual inspection and replace it if necessary.
- ✧ It is recommended to replace the anode magnesium rod at least every 2 years.

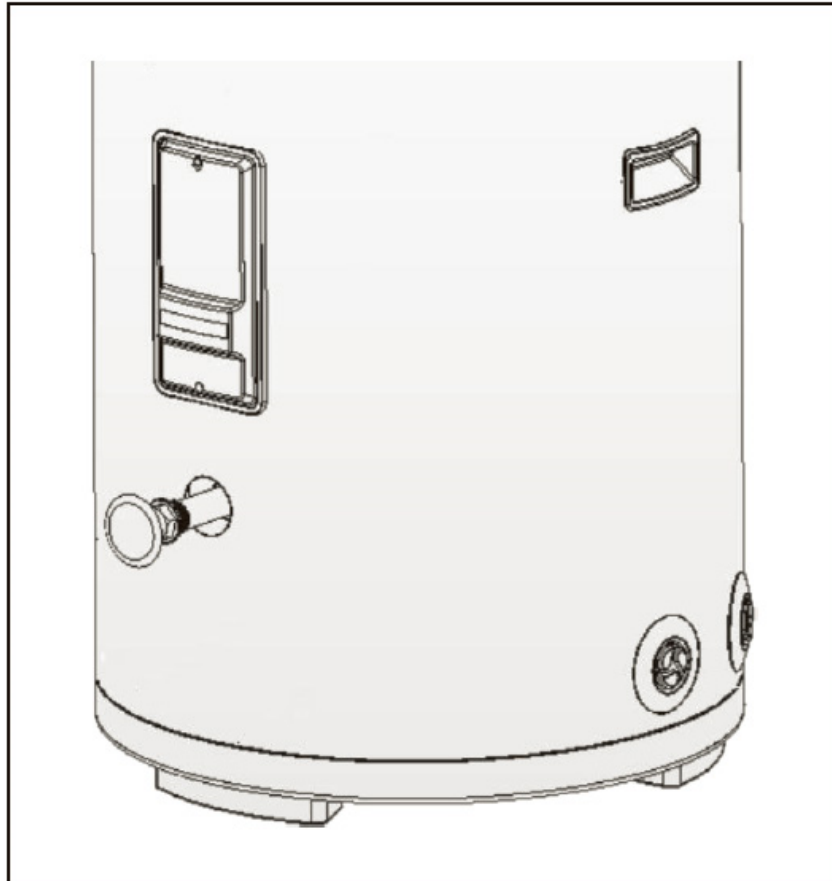



7. Fault code display

Installation, maintenance and repairs can only be carried out by an authorized service supplier. The fault codes and handling measures are listed in the following table:

Abnormal conditions	Warning code	Action	Recovery mode
Low-voltage warning	A12	Stop heating	Automatic recovery or Manual recovery, settable (F51, F52)
Upper water temperature probe failure	A20	Stop heating	Automatic recovery or Manual recovery, settable (F54, F55)
Lower water temperature probe failure	A21	Stop heating	Automatic recovery
Coil probe failure	A22	-	Automatic recovery
Exhaust probe failure	A23	-	Automatic recovery
Environmental probe failure	A25	-	Automatic recovery
Suction probe failure	A26	-	Automatic recovery
Interrupted connection with the external board	A51	Stop heating	Automatic recovery
Excessively high exhaust temperature	A61	Stop heating	Automatic recovery after reduction of exhaust temperature within three times

Notes:

When a fault occurs, the  displays "E1-", and  displays the fault code.

The "warning code" is displayed alternately.

"Automatic recovery" refers to the automatic exit of warning state when the abnormal situation disappears.

"Manual recovery" means that when the abnormal situation disappears, the controller is still locked in the warning state, and needs to be manually turned off and then turned on to recover.

8. Environmental protection

Environmental protection is our basic corporate strategy. For us, the quality of products, our benefits and environmental protection are all equally important goals, and laws and regulations on environmental protection must be strictly observed. We will try our best to use the best technologies and materials under the premise of protecting the environment.

Package

We participate in the recycling programs of various countries to ensure optimal recycling. All our packaging materials are environmentally friendly and recyclable.

Old equipment

The old equipment containing valuable materials should be recycled. These components can be easily separated and composited and also marked accordingly. Therefore, these components can be classified and further recycled or disposed of.

Prior to the end of the service life of this equipment, the personnel who have operational qualifications to the refrigeration circuit must recycle the refrigerant from the sealing system based on the preferred consideration of environmental protection.